

目 录

一、运输作业组织与管理模块..... 2

二、仓储与配送作业组织与管理模块..... 34

三、国际物流作业组织与管理模块..... 150

四、 快递物流作业组织与管理模块.....	213
-----------------------	-----

湖南商务职业技术学院物流管理专业学生技能考核题库

一、运输作业组织与管理模块

○

○

○

--	--	--

○

○

--	--	--	--	--

() 任务描述

- :
-
-



<input type="checkbox"/> <input type="checkbox"/>				<input type="checkbox"/> <input type="checkbox"/>				
<input type="checkbox"/> <input type="checkbox"/>								
						<input type="checkbox"/> <input type="checkbox"/> <input type="checkbox"/> <input type="checkbox"/>		



() 任务描述:

-
-
-



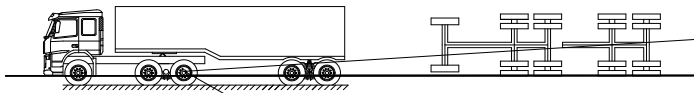

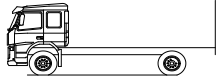
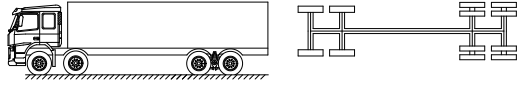
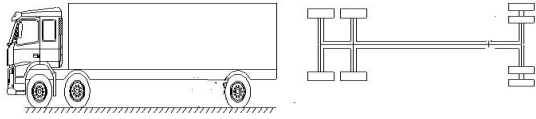

() 任务描述:



○

○

○

○

○

() 任务描述



D

<input type="checkbox"/> <input type="checkbox"/>			<input type="checkbox"/> <input type="checkbox"/>						
<input type="checkbox"/> <input type="checkbox"/>									
						<input type="checkbox"/> <input type="checkbox"/> <input type="checkbox"/> <input type="checkbox"/>			



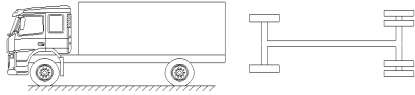
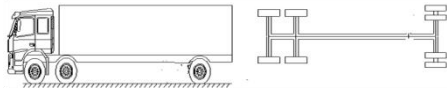
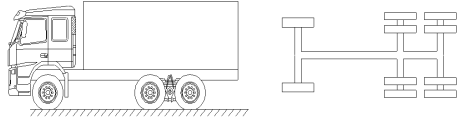

2

3

4

() 任务描述

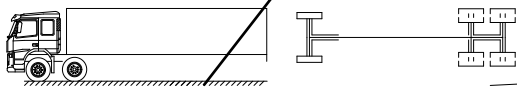
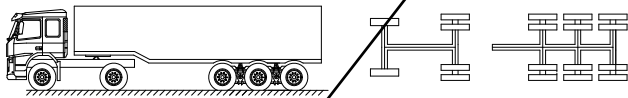
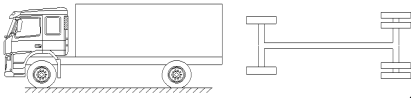
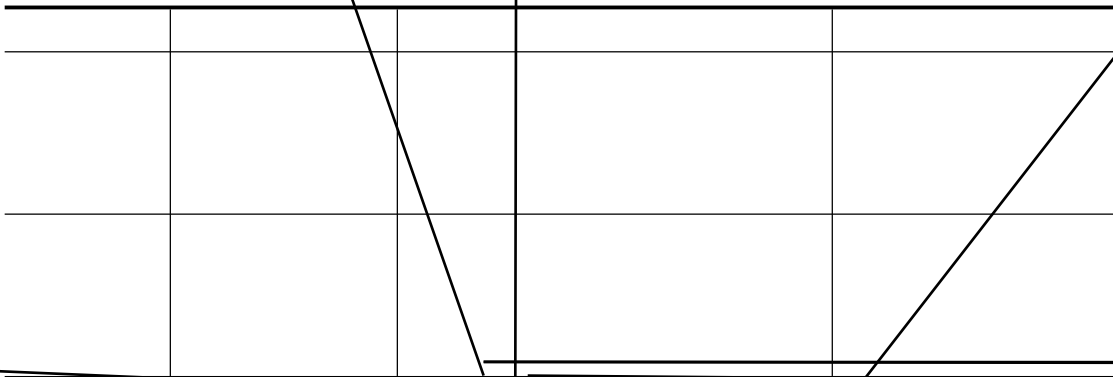



() 任务描述

-
-
-
-
-

() 任务描述

○

Sailing Schedule from : Shenzhen,Shenzhen,Guangdong,China

To : Los Angeles,Los Angeles,CA,United States

Origin City : Shenzhen,Shenzhen,Guangdong,China

Destination City : Los Angeles,Los Angeles,CA,United States

CY/DOOR

CY/DOOR

序列号	航线	船名	航次	截关时间	装货港	预计离港时间	实际离港时间	卸货港
1	YPSW	YM UNISON	59E	2016-04-22 17:00	Yantian	2016-04-25		Los Angeles
2	SEA	NORTHERN JAVELIN	002E	2016-04-23 12:00	Yantian	2016-04-27		Long Beach
3	AAS2	CMA CGM LIBRA	095TXE	2016-04-25 16:00	Yantian	2016-04-28		Long Beach
4	YPSW	YM UBIQUITY	22E	2016-04-29 17:00	Yantian	2016-05-02		Los Angeles
5	SEA	C SCL PUSAN	117E	2016-04-30 12:00	Yantian	2016-05-04		Long Beach
6	AAS2	CMA CGM COLUMBA	097TXE	2016-05-02 16:00	Yantian	2016-05-05		Long Beach
7	SEA	COSCO NINGBO	069W	2016-05-06 11:00	Yantian	2016-05-08		Long Beach
8	YPSW	YM JIREBY	50E	2016-05-06 17:00	Yantian	2016-05-09		Los Angeles
9	SEA	COSCO EXCELLENCE	027E	2016-05-07 12:00	Yantian	2016-05-11		Long Beach
10	AAS2	CMA CGM CENTAURUS	099TXE	2016-05-09 16:00	Yantian	2016-05-12		Long Beach
11	YPSW	YM MASCULINITY	32E	2016-05-13 17:00	Yantian	2016-05-16		Los Angeles



干货箱



	箱体内部尺寸			箱体内容积及载重量		箱门开度尺寸	
	L	W	H	Cu	P	W	H
20'	5898	2352	2393	33.2	21740/28230#	2340	2280
40'	12032	2352	2393	67.7	26630	2340	2280
HC	12032	2352	2698	76.3	26520	2340	2585

冷藏箱



	箱体内部尺寸			箱体内容积及载重量	
	L	W	H	Cu	P
20'	5444	2284	2267	28.5	21135/27160#
40'	11583	2284	2250	58.7	26580
HC	11583	2284	2550	67.9	26380

开顶箱



	箱体内部尺寸			箱体内容积及载重量	
	L	W	P	Cu	P
20'	5900	2330	2337	32.6	21740
40'	12025	2330	2337	65.8	26410

○

○

() 实施条件

() 考核时量

() 评分细则

1

() 任务描述



		<input type="checkbox"/>	<input type="checkbox"/>	<input type="checkbox"/>	<input type="checkbox"/>

□		□		
□		□		

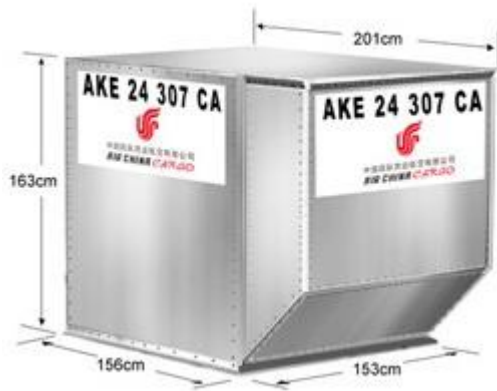

() 实施条件

() 考核时量

() 评分细则

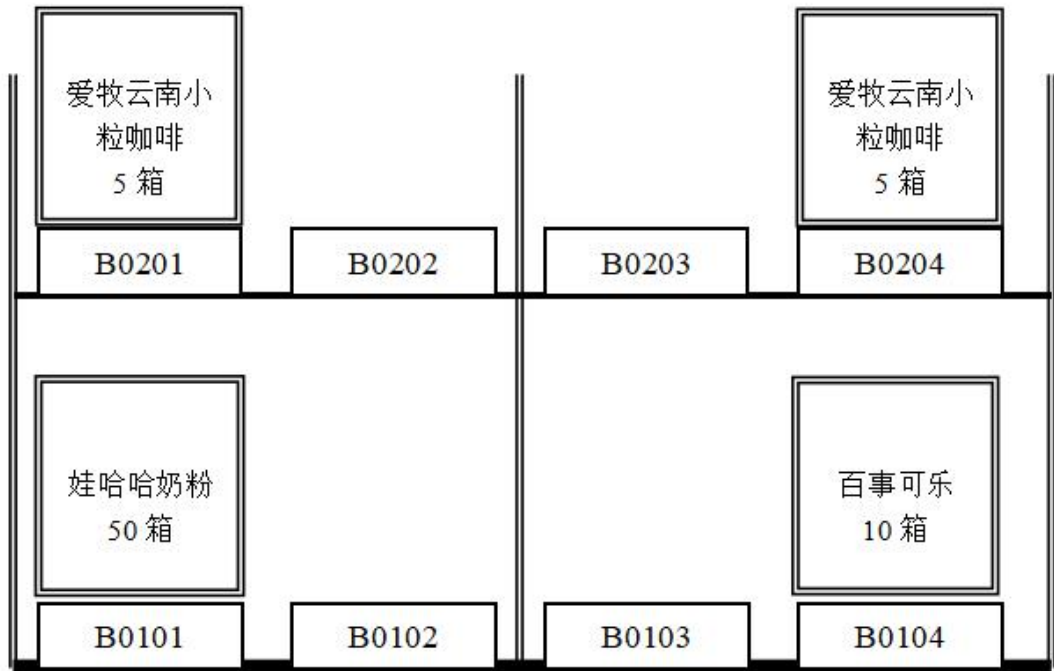

产品运输单

-
-
-
-
-
-
-
-



80				

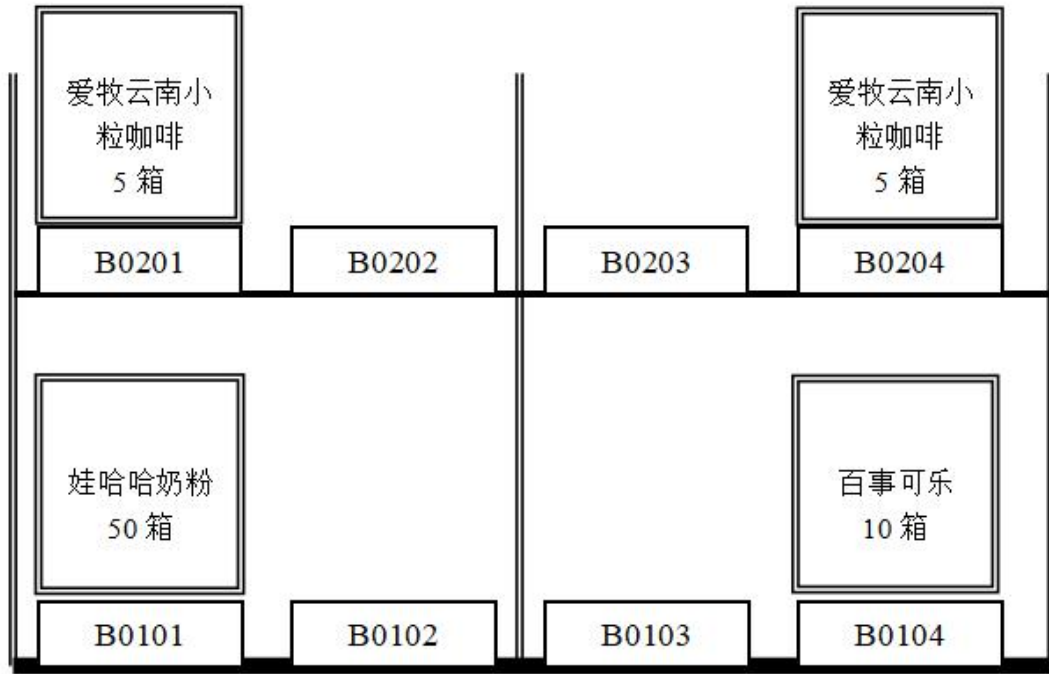

产品运输单

-
-
-
-
-
-
-
-

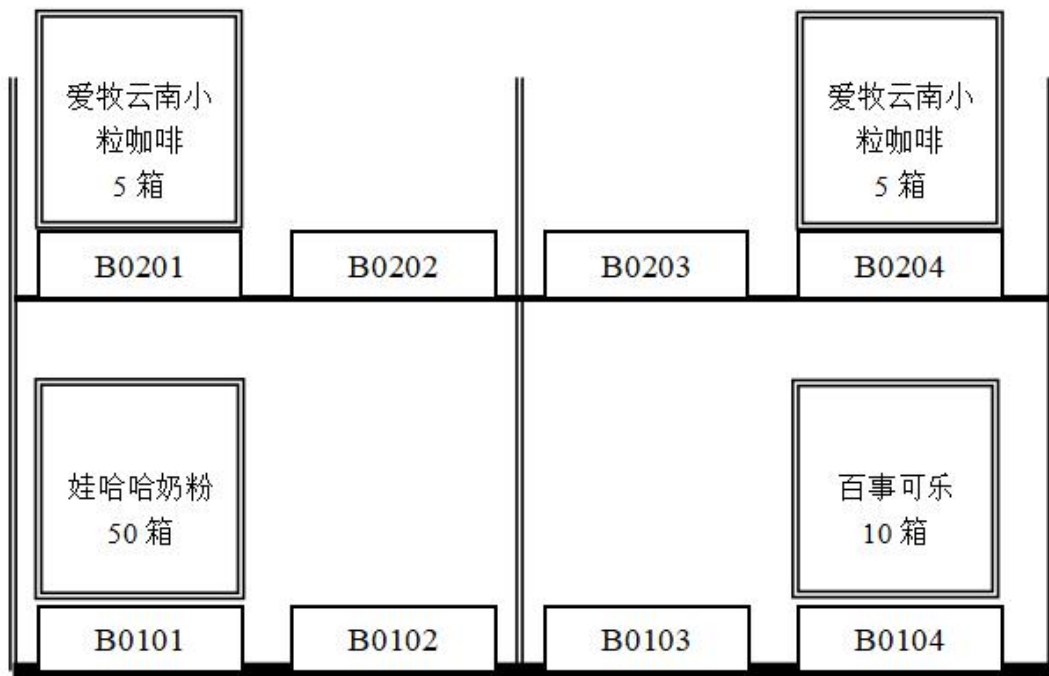

产品运输

-
-
-
-
-
-
-
-

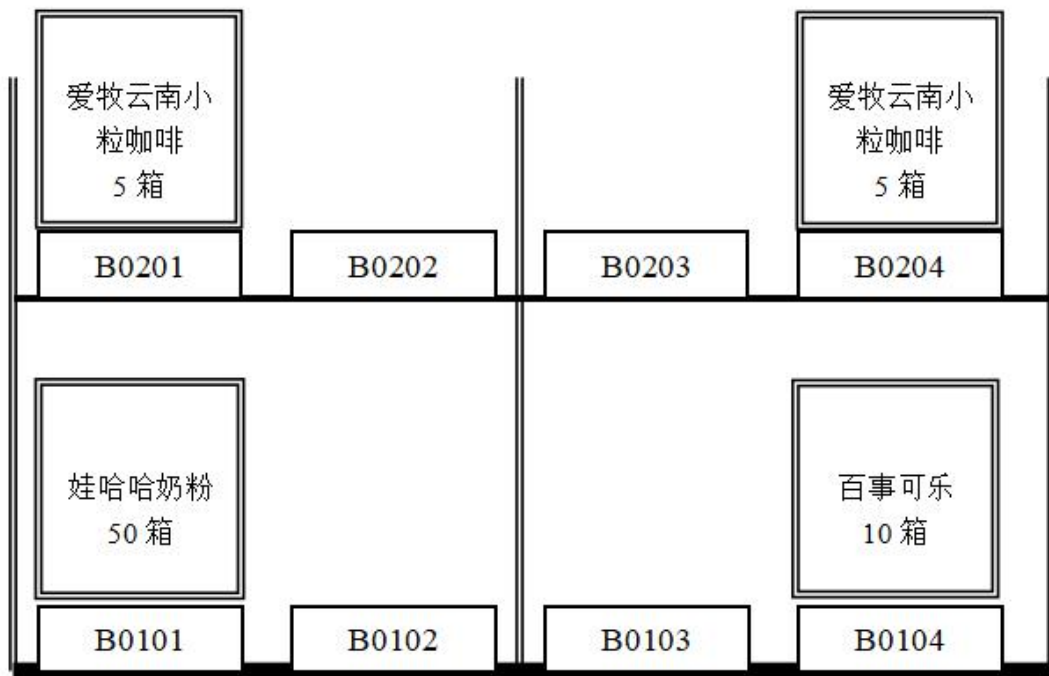

产品运输单

-
-
-
-
-
-
-
-

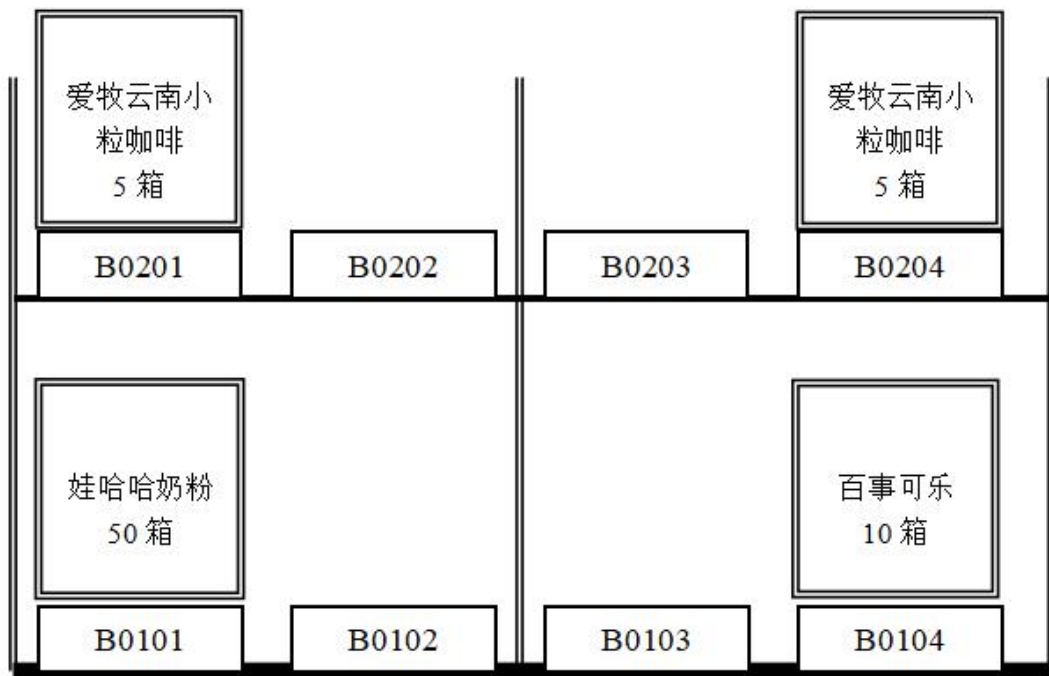

品运输单



^
'^ - > f

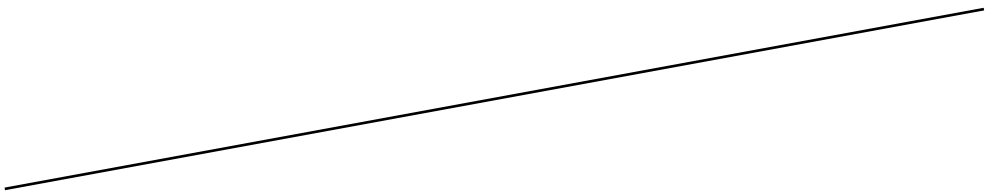

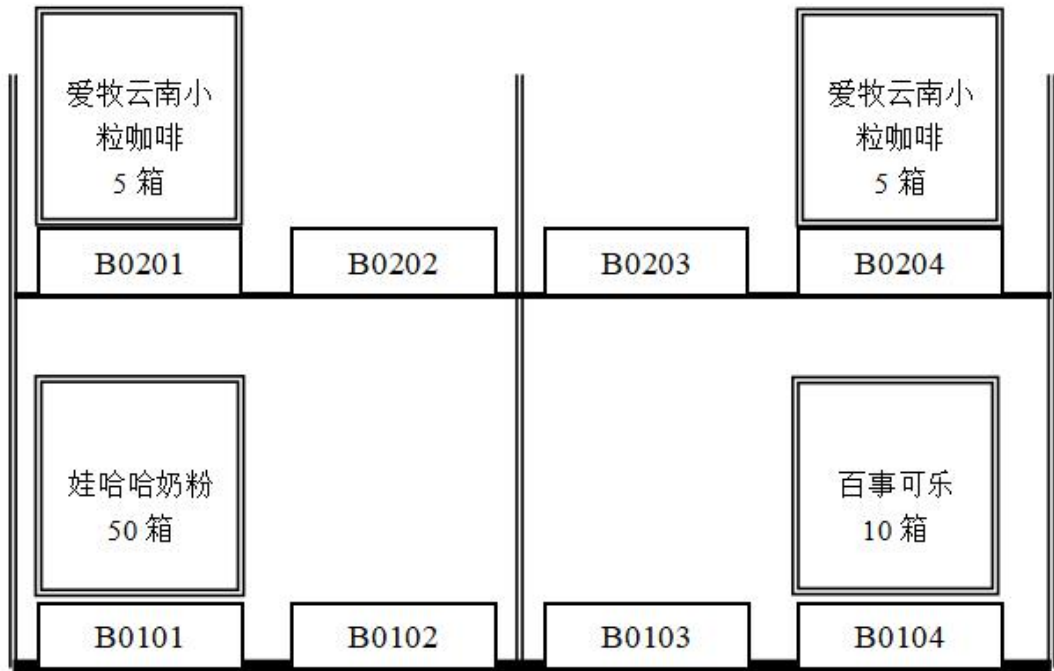

产品运输单

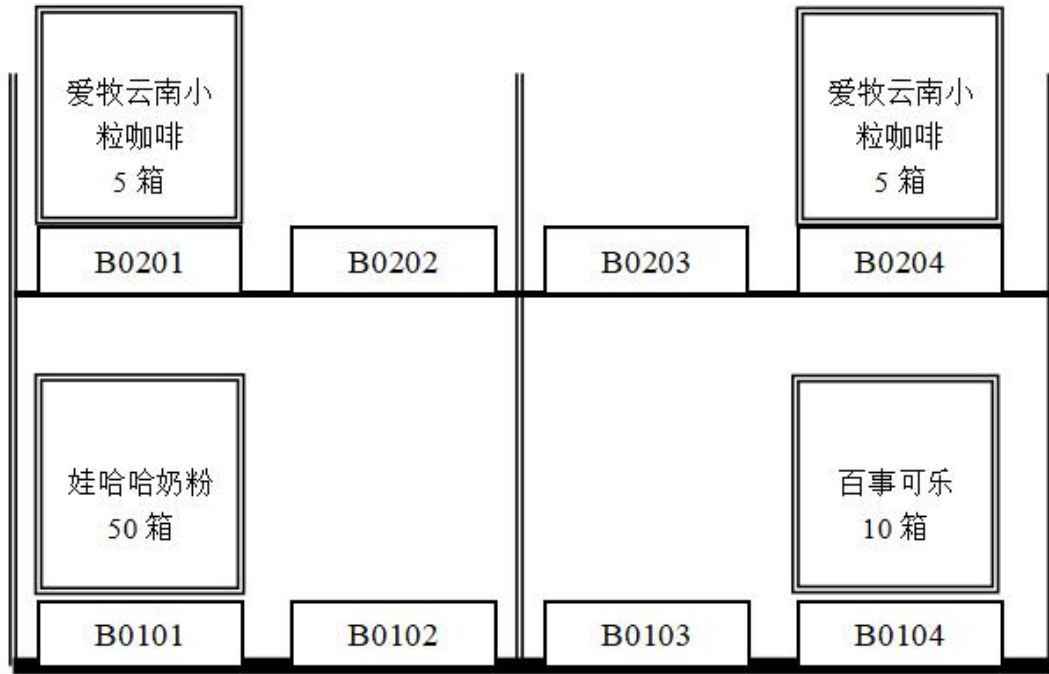

产品运输单

-
-
-
-
-
-
-
-
-

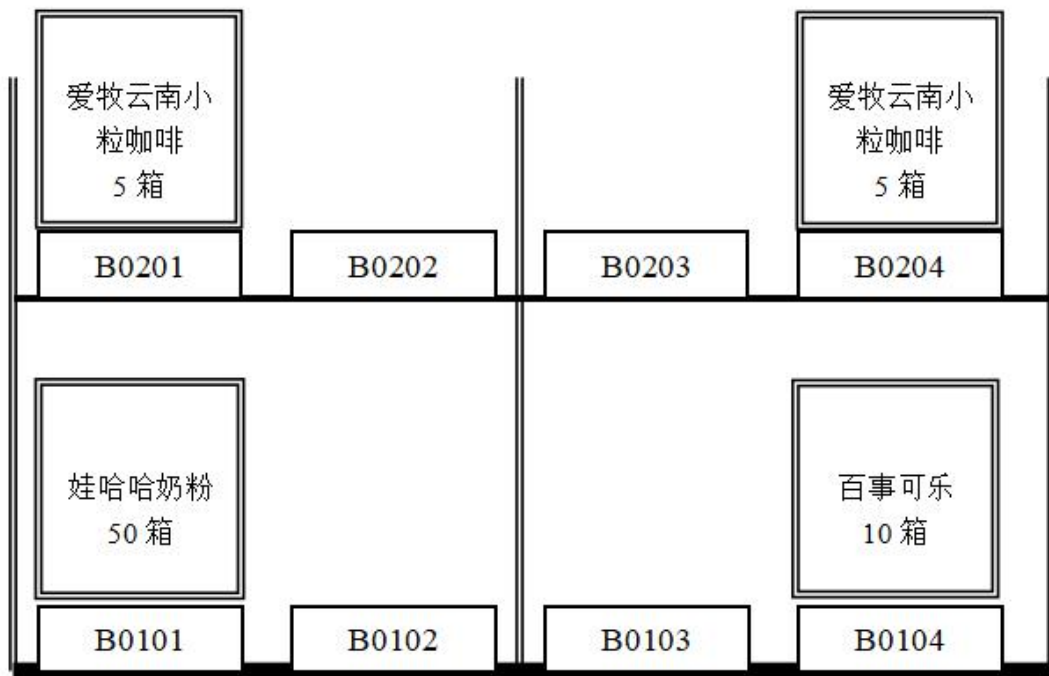

产品运输单

-
-
-
-
-
-
-
-

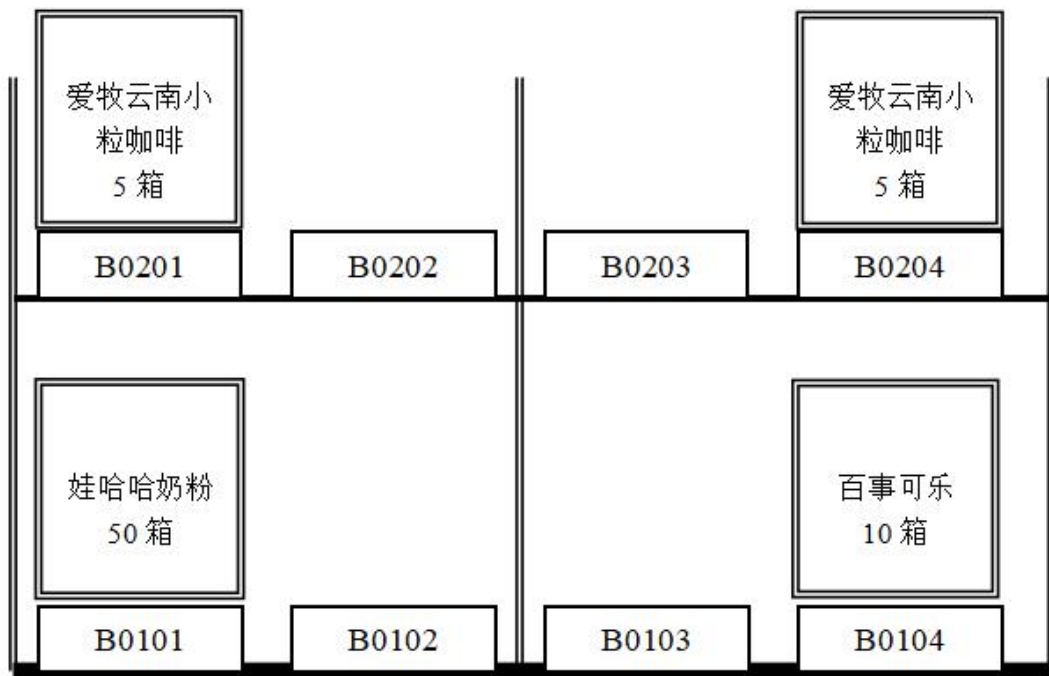

产品运输单

-
-
-
-
-
-
-
-

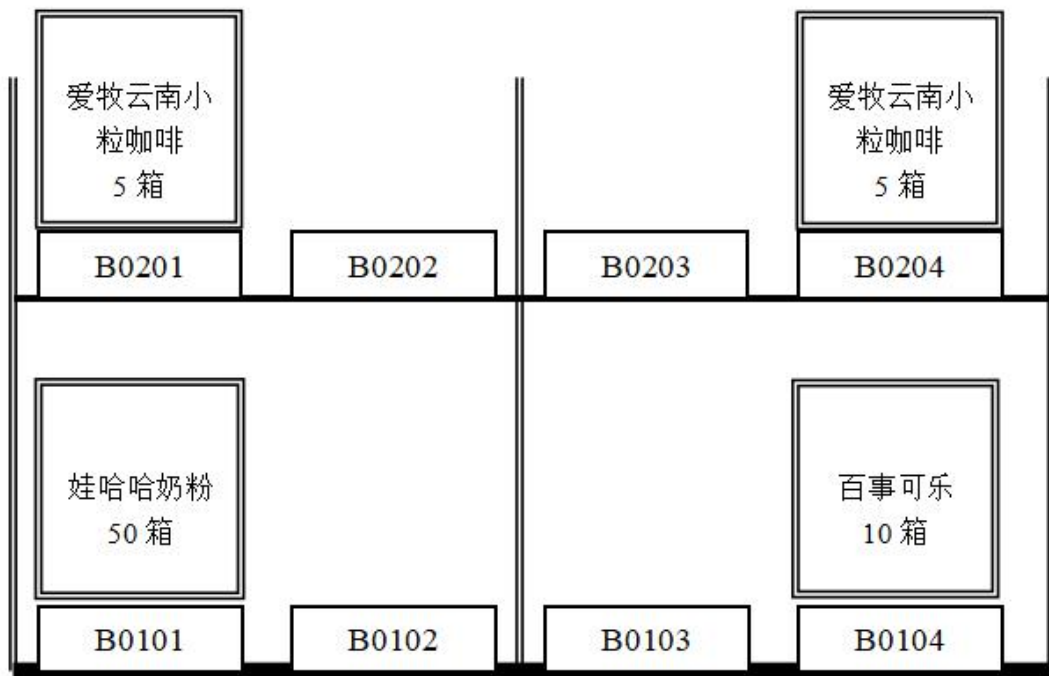

产品运输单

-
-
-
-
-
-
-
-

○

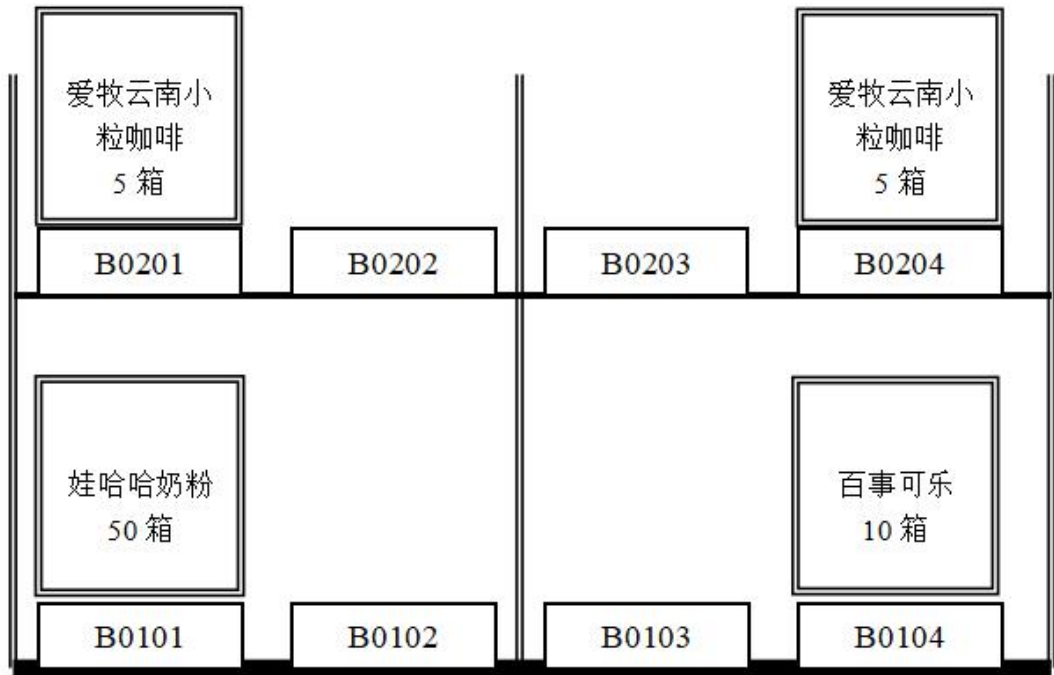



--	--	--	--	--	--

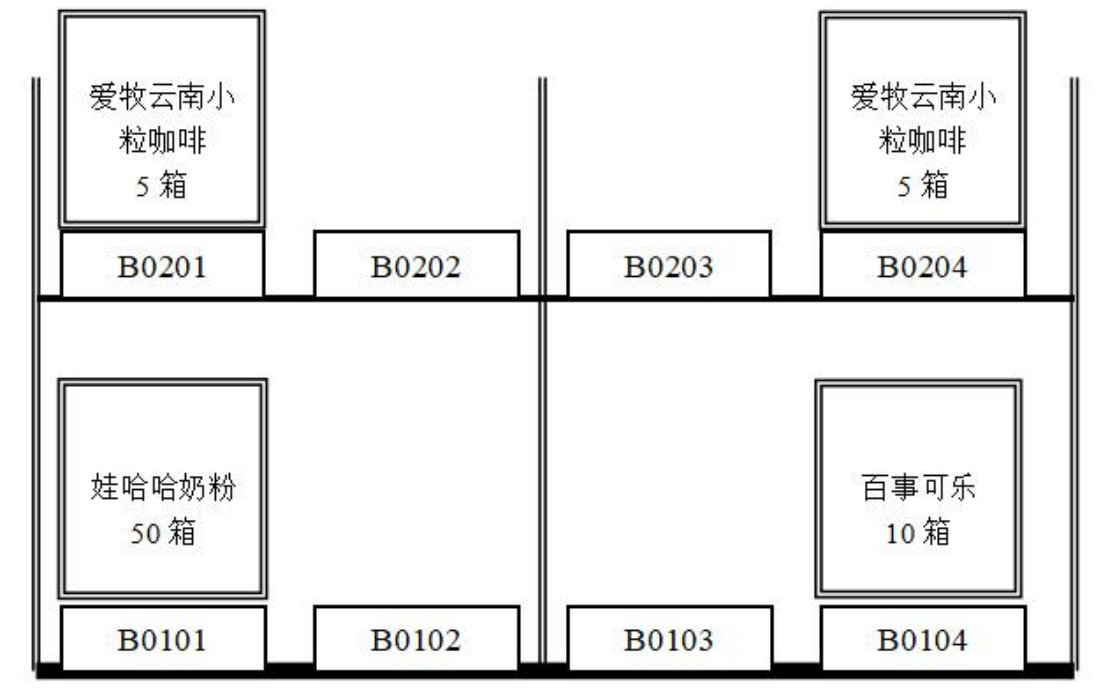

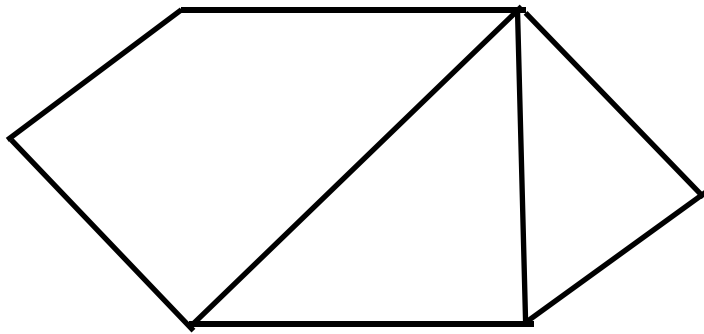

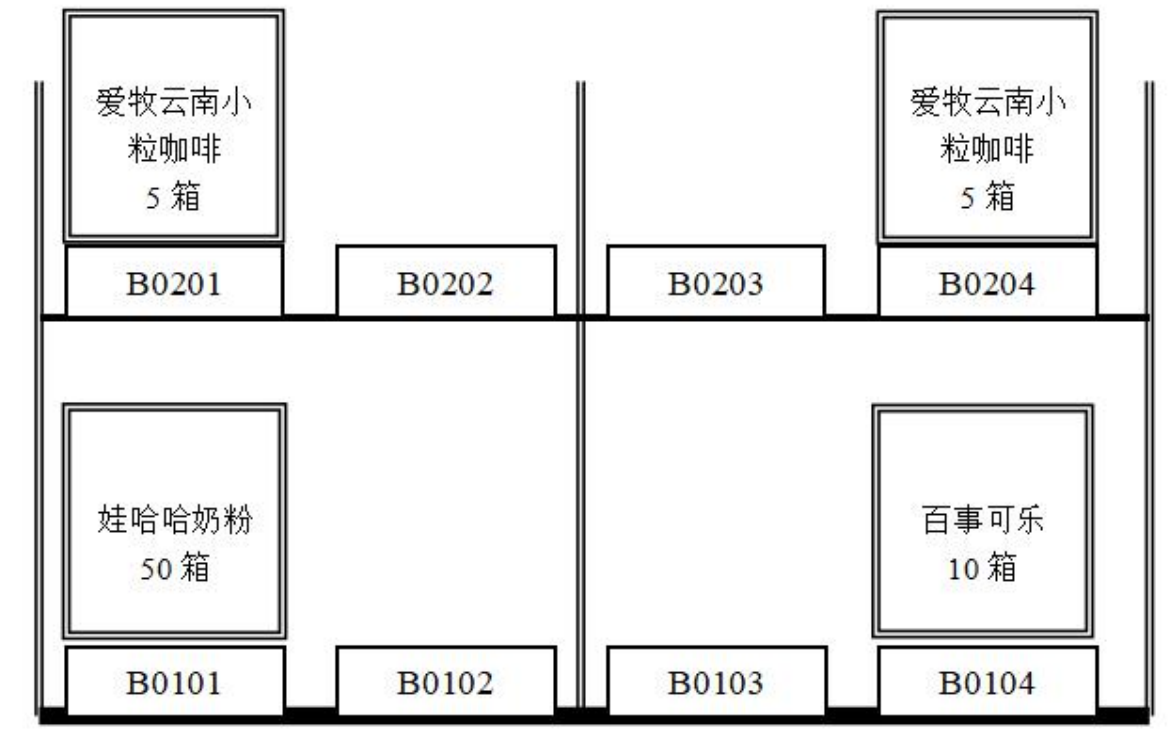

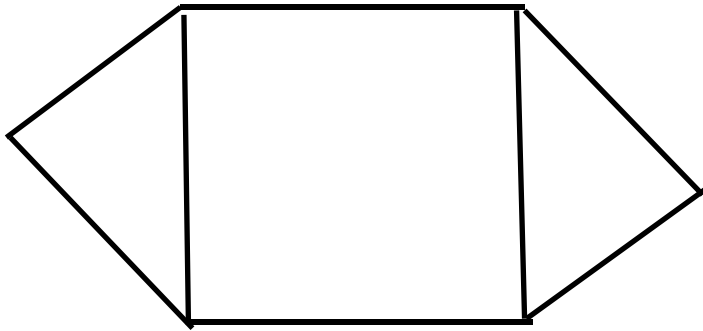

1

--	--

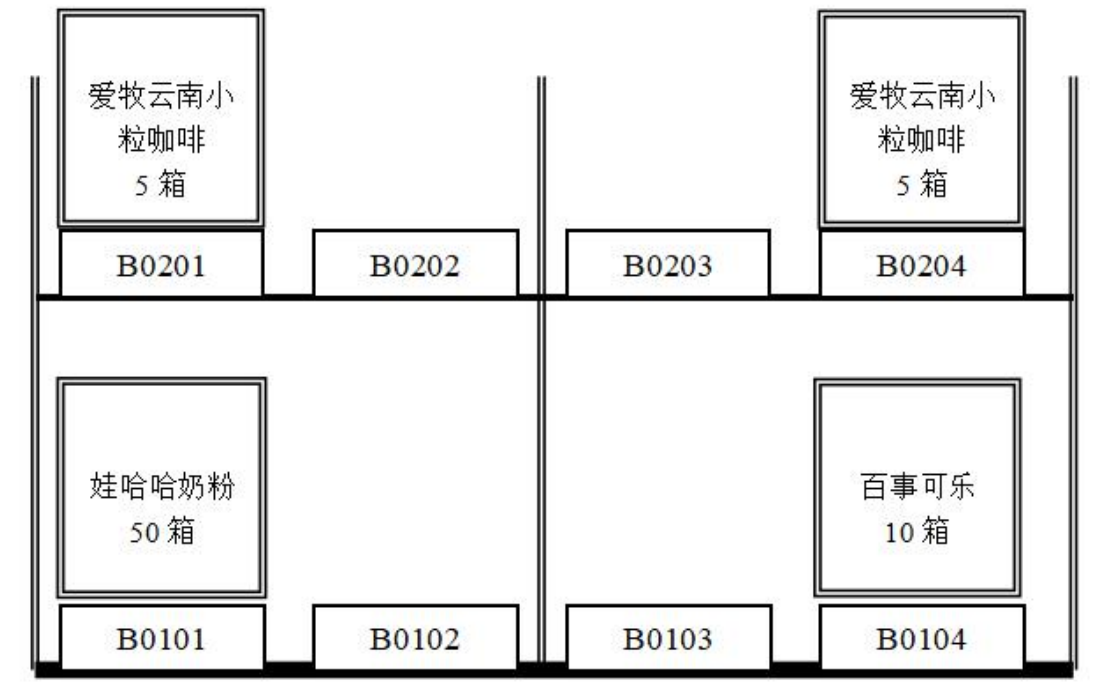

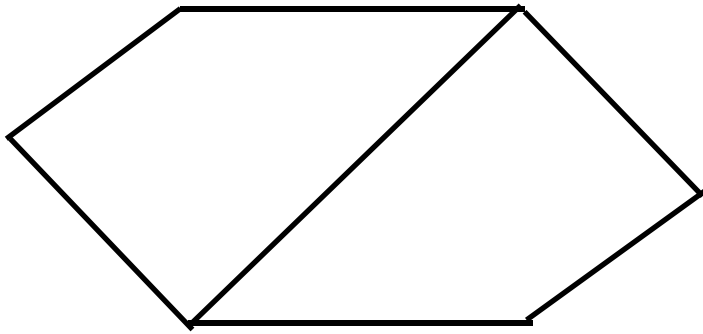

1

--	--	--	--	--	--

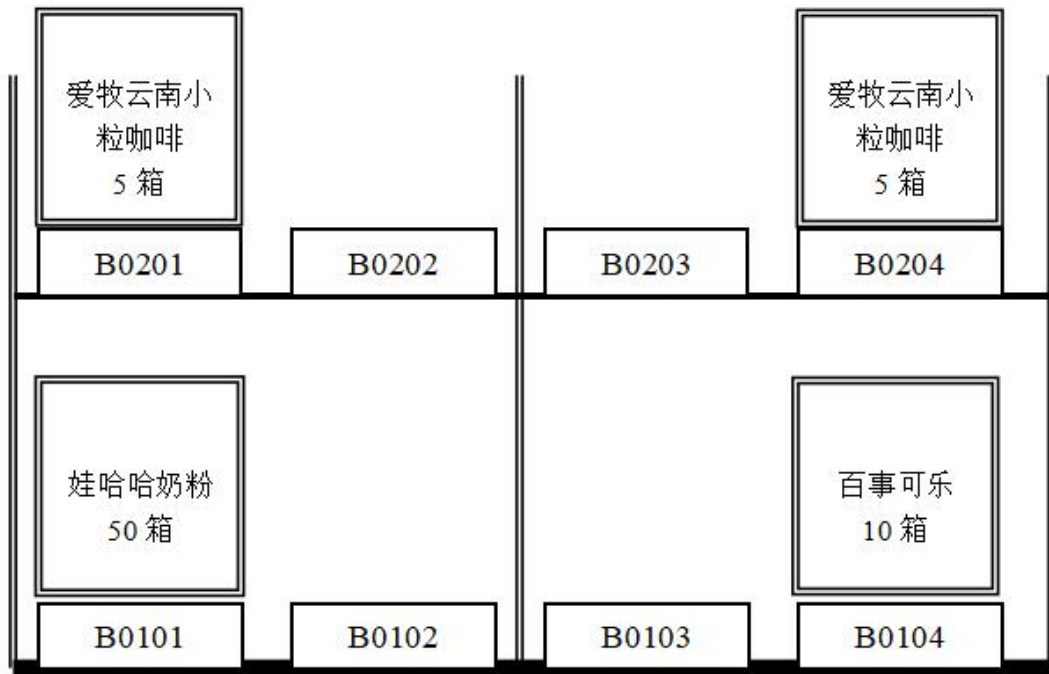

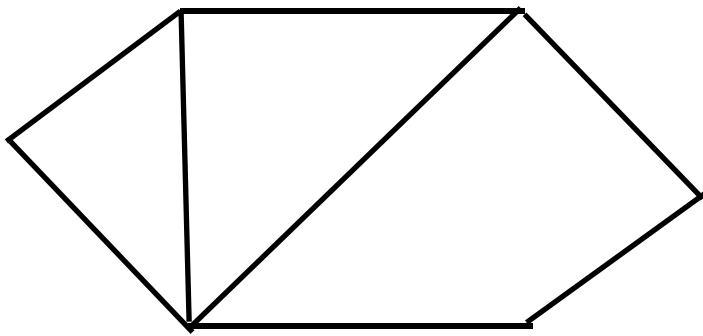

○

○

○

○

○

○

○

○

--	--

○

○

三、国际物流作业组织与管理模块

88

88

88

○

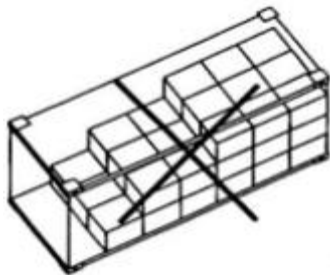
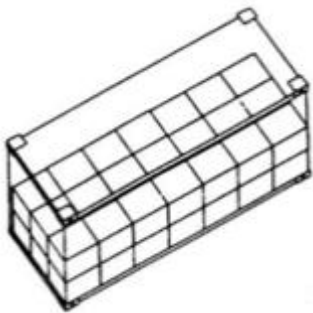

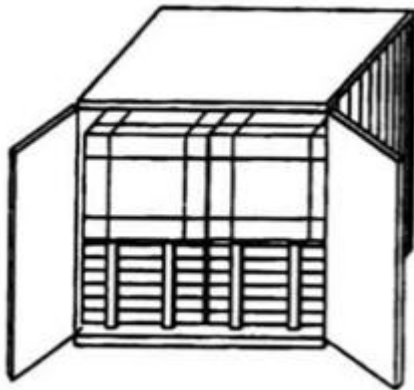
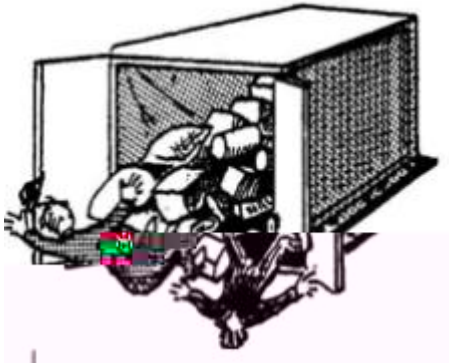
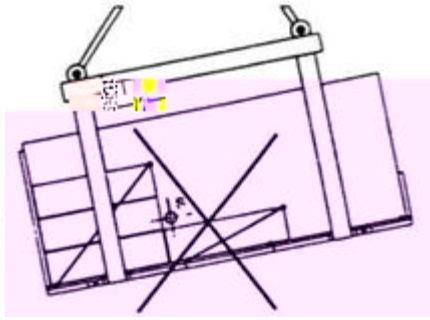
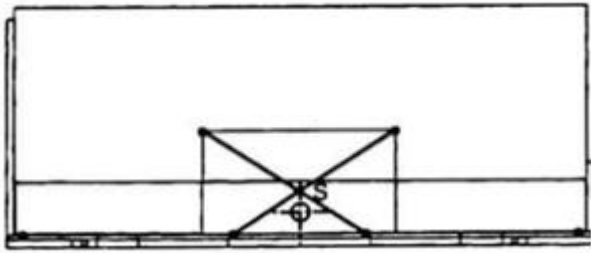

○

船公司	船名/航次	服务代码	航线	装船港/卸船港	启-达日期	天	挂港
Carrier	Voyage	Service	Lane	Load/Unload Port	ETD-ETA	Day	Port
MSC 地中海航运	MASTER 74087		中国-海防	HONG KONG 香港 KAOHSIUNG 高雄	02/25 (二)	0	港
NYK 日本邮船	ITALIAN EXPRESS E 009		中国-香港	HONG KONG 香港 BANGKOK 曼谷	02/25 (二) 03/02 (二)	0	港
CMA-CGM 法国达飞	CMA CGM GENEO 600496		中国-越南	XIAMEN 厦门 DURBAN 德班	02/25 (二) 03/07 (二)	0	港
KLINE 日本邮船	SHUNDAI PLATINUM M 0048		中国-中港	SHANGHAI 上海 PANAMA 巴拿马	02/25 (二) 04/09 (三)	0	港
EMS 德忌利士	OSCO KATHLIN S 02366		中国-美东	HONG KONG 香港 NOUMEA 努美阿	02/25 (二) 04/02 (三)	0	港
FCL 德忌利士	NOVA PERMASAN VPM114		中国-日本 波斯湾-印度	QINGDAO 青岛 MADRAS 马德拉斯	02/25 (二) 03/18 (二)	0	港
ZIM 以色列	HUI HONG 311	CHINA_VIETNAM AM DTK	中国-海防	NINGBO 宁波 HONG KONG 香港	02/25 (二) 03/15 (二)	0	港
SARMARINE 比利時	HEIRE P 1404		中国-欧洲	KAOHSIUNG 高雄 MONTELO	02/25 (二) 04/05 (三)	0	港
DEYU 德忌利士	CAR SAN NICOLA S 01409		中国-中港	SHANGHAI 上海 RIO GRANDE 里奥格兰德	02/25 (二) 04/07 (一)	0	港
OOCL 希腊	OPRESEN EXPRESS S 18808	Pacific Atl anti FAX	中国-美东	SHANGHAI 上海 HALIFAX 哈利法克斯	02/25 (二) 04/14 (一)	0	港

○
○

BEIJING	CN		BJS
Y. RENMINBI	CNY		KGS
BOSTON	 11111	11	111.11
		12	12.12
		13	13.13
		14	14.14
		15	15.15
		16	16.16
		17	17.17
		18	18.18
		19	19.19
		20	20.20

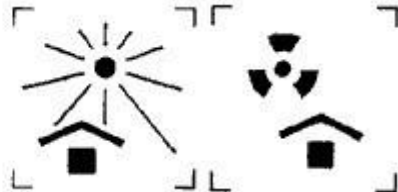
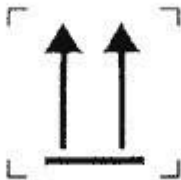
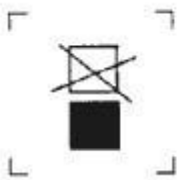

○

○

○

**集装箱设备交接单
EQUIPMENT INTERCHANGE RECEIPT**

OUT 出场

No.

用箱人/运箱人(CNTR. USER/HAULIER)			提箱地点(PLACE OF DELIVERY)		
发往地点(DELIVERED TO)			返回/收箱地点(PLACE OF RETURN)		
船名/航次(VESSEL/VOYAGE No.)		集装箱号(CNTR. No.)		尺寸/类型(SIZE/TYPE)	
提单号(B/L No.)		危险品类别(IMCO CLASS)		箱封号(SEAL No.)	
免费期限(FREE TIME PERIOD)		承运工具牌号(TRUCK WAGON BARGE No.)		普通集装箱(GP. CNTR.)	
货重(CARGO W.)		出场目的/状态(PPS OF GATE-OUT/STATUS)		进场目的/状态(PPS OF GATE-IN/STATUS)	
				出场日期(TIME-OUT)	
				月 日 时	
出场检查记录(INSPECTION AT THE TIME OF INTERCHANGE)					
普通集装箱(GP. CNTR.)		冷藏集装箱(RP. CNTR.)		特种集装箱(SEL. CNTR.)	
发电机(GEN. SET)					
<input type="checkbox"/> 正常(SOUND) <input type="checkbox"/> 异常(DEFFECTIVE)		<input type="checkbox"/> 正常(SOUND) 设定温度(SET) <input type="checkbox"/> 异常(DEFFECTIVE) 记录温度(RECORDED)		<input type="checkbox"/> 正常(SOUND) <input type="checkbox"/> 异常(DEFFECTIVE)	
				<input type="checkbox"/> 正常(SOUND) <input type="checkbox"/> 异常(DEFFECTIVE)	
损坏记录及代号(DAMAGE CODE)					



--	--	--	--	--	--

--	--	--

--	--	--	--	--	--

--	--	--	--	--	--

--	--	--	--	--	--	--	--

○



○

--	--	--

--	--	--	--	--	--

○

○

○

○

四、 快递物流作业组织与管理模块

--	--	--	--	--	--



出示身份证件实名信息录入，确保信息安全

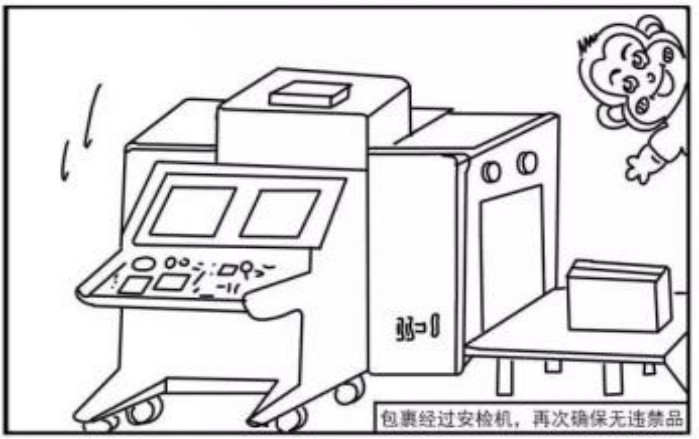

包裹经过安检机，再次确保无违禁品



宅急送，致力于成为中国最有价值的综合物流服务商

--	--	--	--	--	--

--	--	--	--	--	--

[想知道: 中国成都理工大学校园快递具体在哪? 百度知道](#)

3个回答 - 提问时间: 2014年02月10日

最佳答案 问: [成都理工大学](#) 快递在哪个位置, 国际, 圆通, 顺丰在哪个位置, 中通, 申通在哪个位置, 常用的快递公司?

[成都理工大学](#) 快递在哪个位置, 国际, 圆通, 顺丰在哪个位置, 中通, 申通在哪个位置, 常用的快递公司?

--	--	--	--

--	--	--	--

1

<hr/>
